

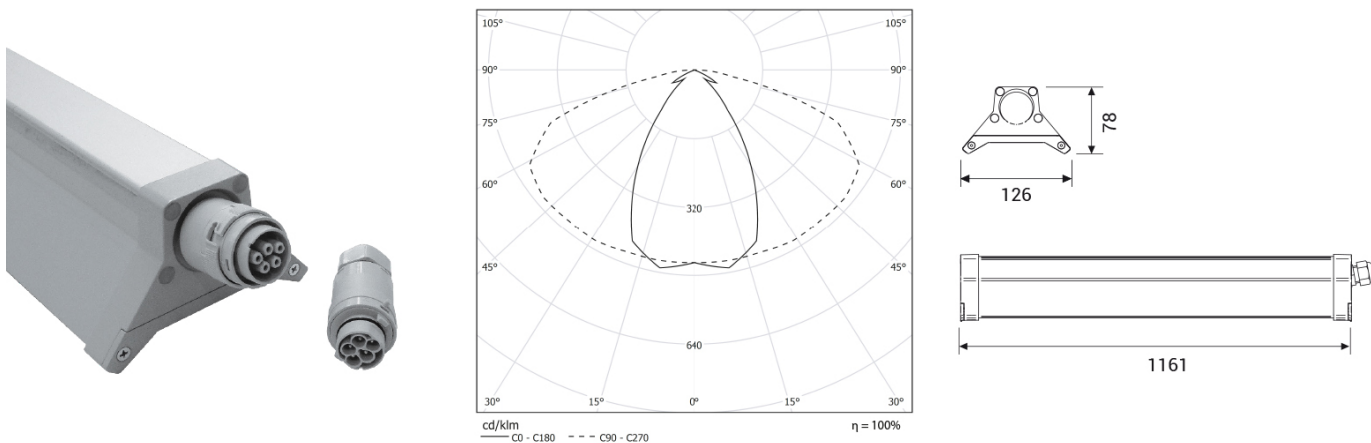



STILLA WB FC High Power

Fixture for continuous-row with quick connector and through wiring.



CODE		LIGHT STREAM	SIZE	CERTIFICATIONS
05WB46L465FCEM	46W 350mA 4000K	4939lm	1161mm	  

Optics

Wide beam optic co-extruded into the main diffuser.

Specifications

350mA integrated driver
 CRI > 80
 Mac Adams 3
 Life Time: L80/B50 >50.000h
 5 years complete warranty
 Eye safety: risk-free (RG 0) in accordance with EN62471:2009
 Temperature range: -25° / +45°

Body

Anodized aluminum body and die-cast end caps.

Legal references





In compliance with the safety standards EN 60 598-1 and UNI EN 12464-1 (lighting for working places).

Wiring

EM: Built-in wiring 230-240V/50-60Hz with power factor >0.97 with 1h emergency block.

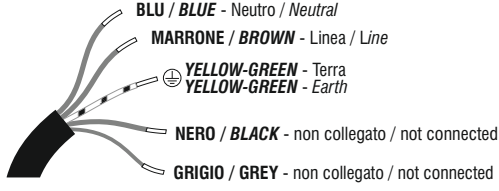
STILLA

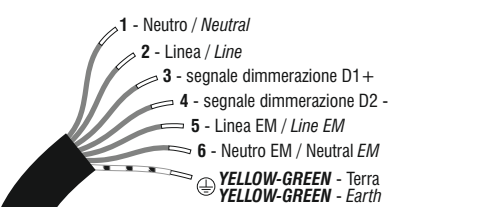
Istruzioni per il cablaggio Wiring instructions

<p>ON/OFF</p>  <p>BLU / BLUE - Neutro / <i>Neutral</i> MARRONE / BROWN - Linea / <i>Line</i> YELLOW-GREEN - Terra YELLOW-GREEN - <i>Earth</i> NERO / BLACK - non collegato / <i>not connected</i> GRIGIO / GREY - non collegato / <i>not connected</i></p>	<p>ON/OFF + emergenza ON/OFF + <i>emergency</i></p>  <p>BLU / BLUE - Neutro / <i>Neutral</i> MARRONE / BROWN - Linea / <i>Line</i> YELLOW-GREEN - Terra YELLOW-GREEN - <i>Earth</i> NERO / BLACK - Linea EM / <i>Line EM</i> GRIGIO / GREY - Neutro EM / <i>Neutral EM</i></p>
<p>DALI / SWITCH DIM</p>  <p>BLU / BLUE - Neutro / <i>Neutral</i> MARRONE / BROWN - Linea / <i>Line</i> GIALLO - VERD - Terra YELLOW-GREEN - <i>Earth</i> NERO - segnale dimmerazione D1+ BLACK - <i>dimming signal D1+</i> GRIGIO - segnale dimmerazione D2- GREY - <i>dimming signal D2-</i></p>	<p>DALI / SWITCH DIM + emergenza DALI / SWITCH DIM + <i>emergency</i></p>  <p>1 - Neutro / <i>Neutral</i> 2 - Linea / <i>Line</i> 3 - segnale dimmerazione D1+ 4 - segnale dimmerazione D2- 5 - Linea EM / <i>Line EM</i> 6 - Neutro EM / <i>Neutral EM</i> YELLOW-GREEN - Terra YELLOW-GREEN - <i>Earth</i></p>
<p>ON/OFF accensioni multiple ON/OFF <i>multiple switching</i></p>  <p>BLU / BLUE - Neutro / <i>Neutral</i> MARRONE / BROWN - Linea / <i>Line</i> YELLOW-GREEN - Terra YELLOW-GREEN - <i>Earth</i> NERO / BLACK - Linea 2 / <i>Line 2</i> GRIGIO / GREY - Linea 3 / <i>Line 3</i></p>	

// **Avvertenze.** La sicurezza dell'apparecchio è garantita solamente con l'uso appropriato delle presenti istruzioni che devono essere lette e conservate. • Togliere tensione di rete prima della sostituzione delle lampade e comunque prima di ogni operazione di manutenzione. • Non coprire l'apparecchio con panni o con quant'altro possa causare un eccessivo surriscaldamento. • La nostra azienda declina ogni responsabilità per danni causati da uno scorretto utilizzo o dalla manomissione dell'apparecchio stesso. • Per la sostituzione di componenti usurati rivolgersi a personale qualificato. • L'apparecchio non deve essere smaltito come rifiuto urbano. Deve essere soggetto a raccolta separata per evitare danni all'ambiente nel rispetto della direttiva 2002/96 e delle leggi nazionali per lo smaltimento del prodotto a fine vita. Il mancato rispetto di quanto sopra è sanzionato dalla Legge. • Si prega di informarsi in merito al sistema locale di raccolta differenziata per i prodotti elettrici ed elettronici.

// **Warning.** The safety of the fixture is guaranteed only under the correct use of the present instructions, which have to be read and kept. • Turn off the net voltage before the replacement of the lamp and however before any maintenance action. • Do not cover the fixture with clothes or something else which could cause an excessive overheating. • Our company declines all responsibility for damages caused by an incorrect use or by the tampering of fixture itself. • For replacement of worn out components please address to the skilled staff. • The fixture could not be disposed as urban waste. It must be subject o separate waste collection to avoid environmental damage in compliance with directive 2002/96 and national laws for the disposal of product at the end of its working life. The non-compliance of the above mentioned directive will be sanctioned by Law. • We ask you to kindly get information about local separate waste collection system for electric and electronic products.

STILLA

// Istruzioni per il montaggio // Assembly instructions

05 xB 24 Lx 65 - L 1161
05 xB 46 Lx 65 - L 1161
05 xB 95 Lx 65 - L 1161

05 xB 30 Lx 65 - L 1441
05 xB 57 Lx 65 - L 1441
05 xB 119 Lx 65 - L 1441

CLASSE/CLASS I
24W 48LED / 46W 88LED / 95W 240LED (L 1161)
30W 60LED / 57W 110LED / 119W 300LED (L 1441)

220-240V AC 50-60Hz

ATTENZIONE! Possibile radiazione ottica rischiosa emessa da questo prodotto. Rischio fotobiologico: gruppo di rischio 1
CAUTION! Possibly hazardous optical radiation emitted from this product. Photobiological safety: risk group 1

MADE IN ITALY



esse-ci
LIVING LIGHT

Esse-Ci Srl
Viale del Lavoro 25, 35010 Vigonza (PD) Italy
Tel. +39 049 8959511, Fax +39 049 628278
info@esse-ci.it, www.esse-ci.it

Attenzione: prima di procedere con ciascuna delle seguenti operazioni, togliere la tensione di rete ed utilizzare i guanti in dotazione.

Attention: before proceeding with each of the following operations, switch off the power supply at the consumer unit. Use the gloves supplied.

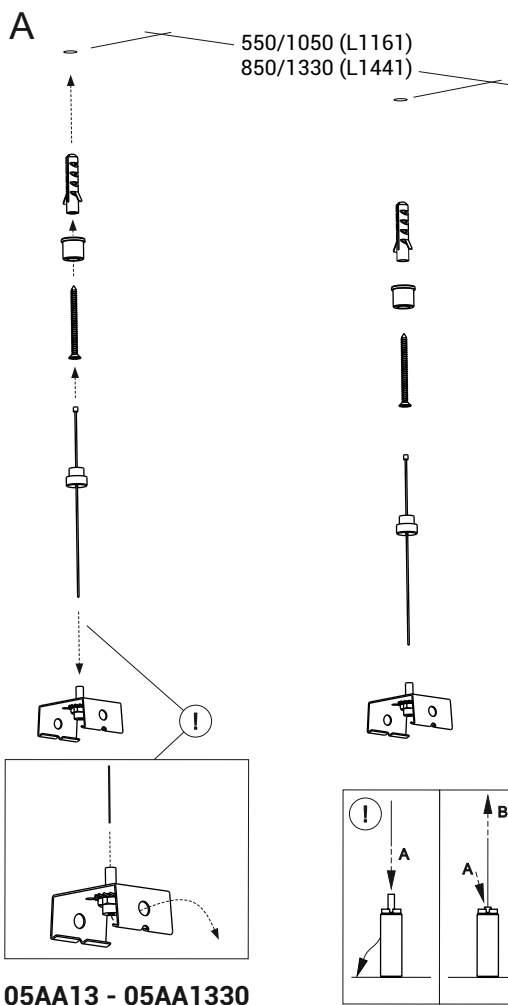

05AA13 - 05AA1330

05AAVTS - 05AAVTL

B (opzionale - optional)

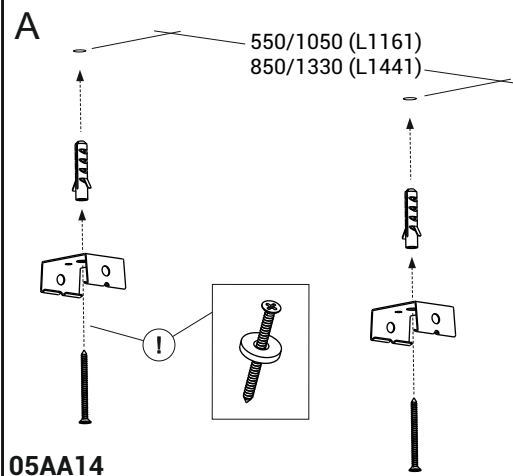

05AA14

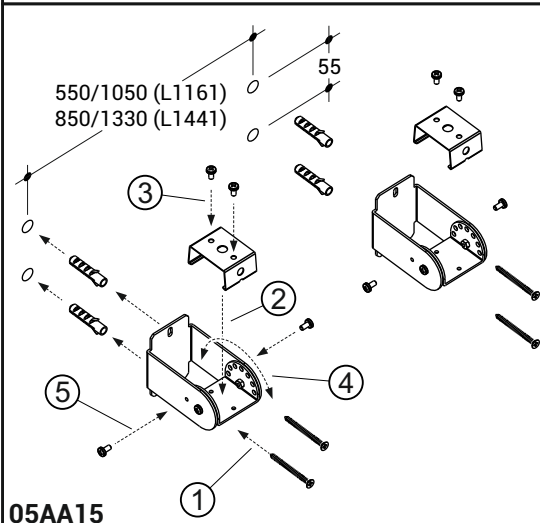

05AA15

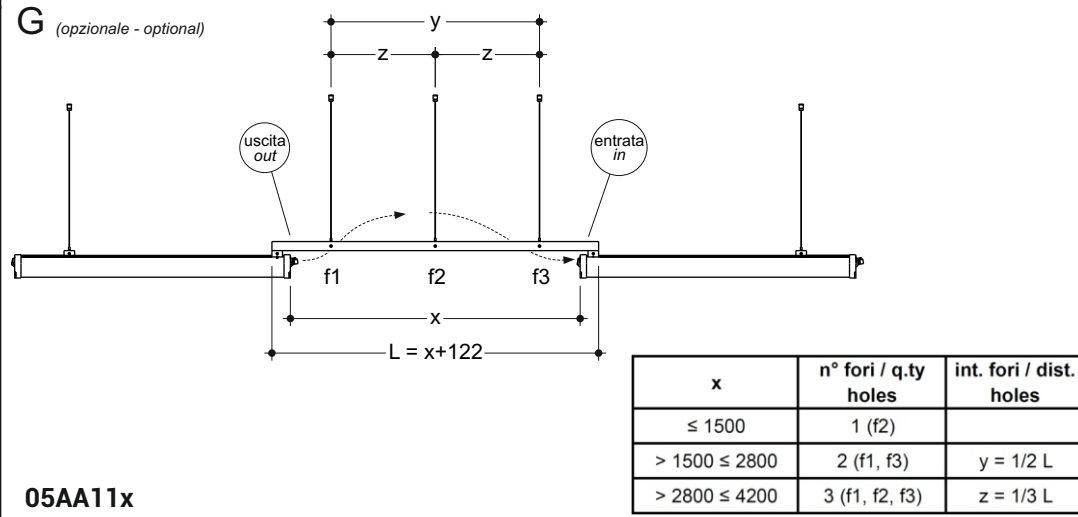
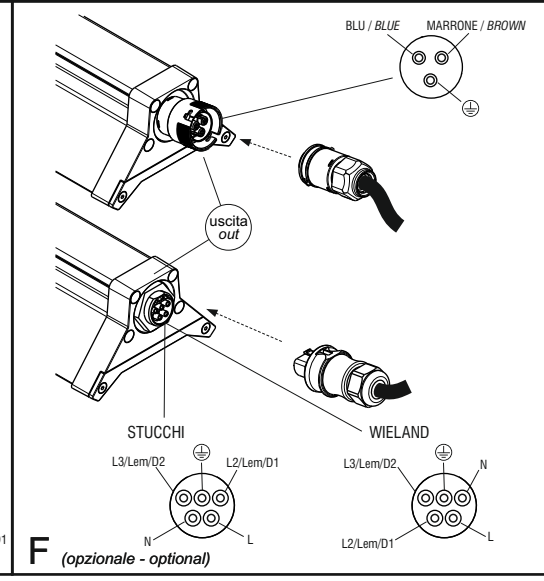
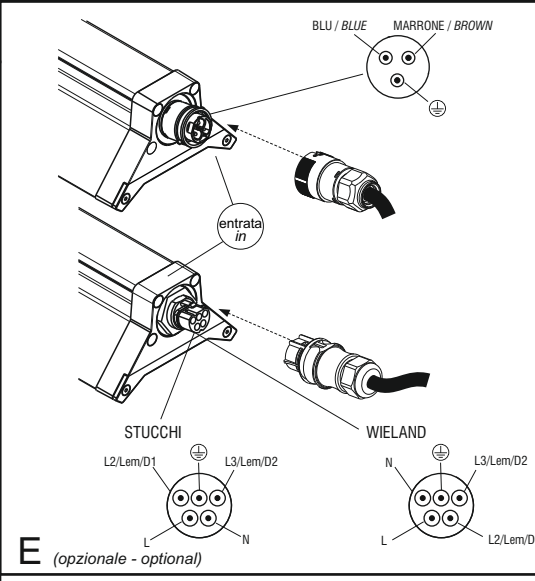
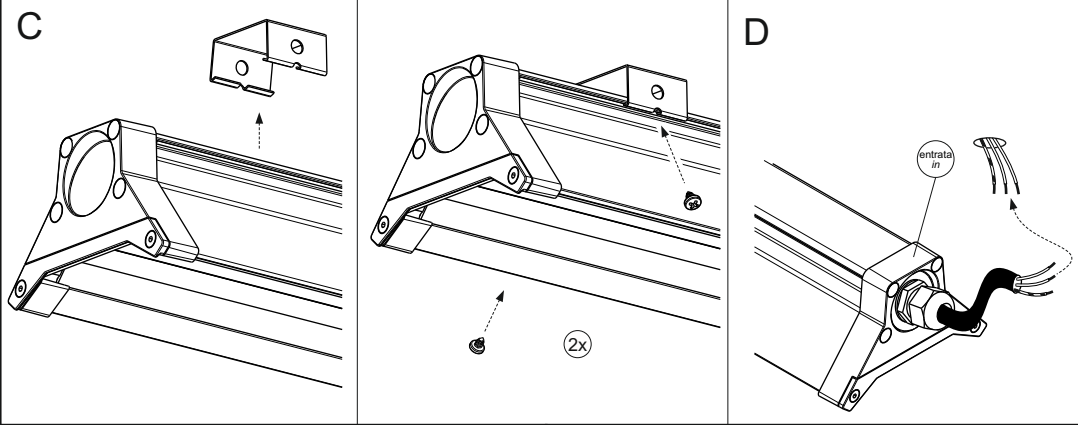

05AA11x